



OPERATING INSTRUCTIONS

ENGLISH

Calibre Number:
 Numéro de calibre :
 Número de calibre:
 Kalibernummer:
 Numero di calibro:
 キャリバー番号:
 칼리버 번호:
 機芯號:
 机芯号:
 رقم العيار:

Contents

A

Fig. I-XVI
 Fig. I-XVI
 Fig. I-XVI
 Abb. I-XVI
 Fig. I-XVI
 図 I-XVI
 그림 I-XVI
 圖 I-XVI
 圖 I-XVI
 I-XVI الشكل

Figure Number:
 Numéro de figure :
 Número de figura:
 Abb. Nr.:
 Numero di figura:
 図番号:
 그림 번호:
 圖片編號:
 图片编号:
 رقم الشكل:

Page:
 Page :
 Página:
 Seite:
 Pagina:
 ページ:
 페이지:
 頁碼:
 页码:
 الصفحة:

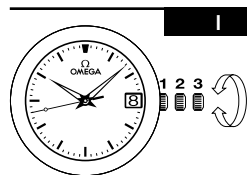

Number of calibres:
 1424, 1532, 2500, 2507, 4561, 4564, 8500,
 8501, 8507, 8508, 8511, 8520, 8521, 8700,
 8701, 8800, 8801, 8900, 8901, 8910

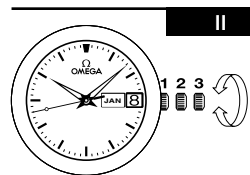

Number of calibres:
 8601, 8611, 8902, 8903

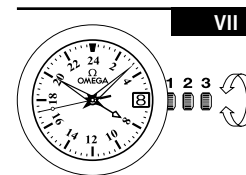

Number of calibres:
 8605, 8615, 8906

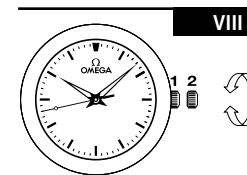

Number of calibres:
 2403, 8421, 8703, 8806, 8807

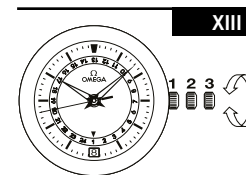

Number of calibres:
 8938, 8939

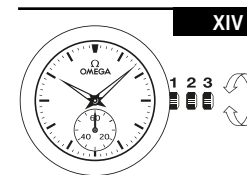

Number of calibres:
 8926, 8927

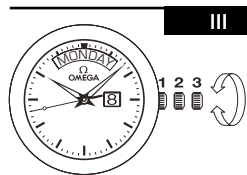

Number of calibres:
 8602, 8612

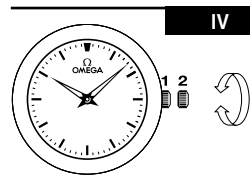

Number of calibres:
 1376, 4061

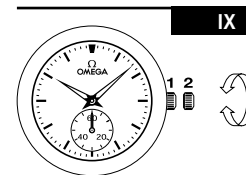

Number of calibres:
 2202, 2211, 8804, 8805

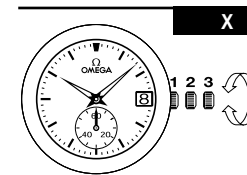

Number of calibres:
 8802, 8803, 8916, 8917

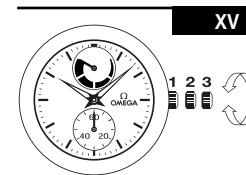

Number of calibres:
 8934, 8935

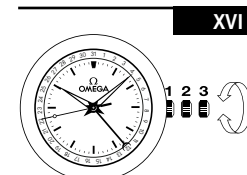

Number of calibres:
 8936

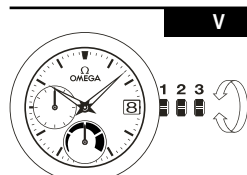

Number of calibres:
 2627, 8810, 8811

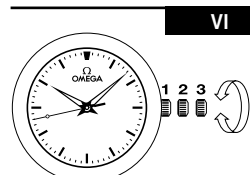

Number of calibres:
 8400, 8401, 8912, 8913, 8928, 8929

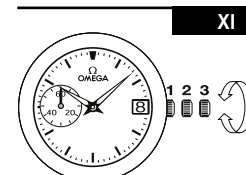

Number of calibres:
 8704, 8705

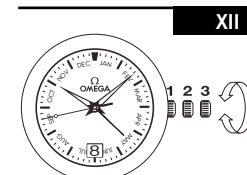

Number of calibres:
 8922, 8923

Contents

1	Introduction	
	– Special recommendations / Safety and environmental protection	4
	– Leather straps / Anti-reflective treatment / Screw-down crown	8
	– OMEGA International Warranty	9
2	Operating instructions	
	– Quartz watch	
	Calibres: 1376, 1532, 4061, 4561, 4564	17
	1424	18
	– Manual & Self-winding watch	
	Calibres: 8400, 8401, 8500, 8501, 8507, 8508, 8511, 8900, 8901, 8910, 8912, 8913, 8916, 8917, 8926, 8927, 8928, 8929, 8934, 8935, 8936	19
	8601, 8611, 8902, 8903, 8922, 8923	21
	8602, 8612	22
	2500, 2507, 2627, 8520, 8521, 8700, 8701, 8704, 8705, 8800, 8801, 8802, 8803, 8810, 8811	23
	2202, 2211, 2403, 8421, 8703, 8804, 8805, 8806, 8807	24
	– Manual-winding chronograph	
	Calibres: 321, 1861, 1863, 1865, 1869, 3201, 3203, 3861, 3869	25
	9906, 9908, 9909	27
	– Self-winding chronograph	
	Calibre: 3330	28
	Calibres: 3113, 3304, 3888	29
	9300, 9301, 9900, 9901, 9920	31
	– Self-winding chronograph with moon phase	
	Calibres: 9904, 9905	32
	– Manual-winding chronograph with moon phase	
	Calibre: 9914	33
	– Self-winding split-seconds chronograph	
	Calibre: 3612	34
	– GMT, Worldtimer, GMT Chronograph	
	Calibres: 3603, 8605, 8615, 8906, 8938, 8939, 9605, 9615	36
3	Specific sections/general information	
	– Chronometer / Master Chronometer / 15,000 gauss	39
	– Thermocompensated quartz	40
	– Helium escape valve	41
	– Measurement scales	43
	– Buckles and clasps	46
	– Ploprof bezel and crown	52
	– Bullhead crown / Retractable crown	53
	– CHRONO LOCK / Strap with quick interchangeable system	54
	– Pictograms	56

Fabricant / Manufacturer / Hersteller

OMEGASA

Rue Jakob-Stämpfli 96

CH-2502 Bienne

Switzerland

What must I do to ensure that my OMEGA watch provides me with excellent service for many years?

Magnetic fields: avoid contact with magnets, or putting your watch on top of loudspeakers, refrigerators or magnetic cases for iPads or other tablets, since such objects generate magnetic fields which could disturb the functions of your watch. Watches that include Master Co-Axial or Master Chronometer in their name are unaffected by magnetic fields up to 15,000 gauss (1.5 tesla).

Swimming in the sea: always rinse your watch with fresh water afterwards.

Shocks: whether physical, thermal or other, avoid them.

Crown: always push the crown back into the case (position 1) to prevent water from entering the mechanism. Do not operate the crown under water.

Screw-down crown: always ensure that the crown is screwed back in completely to prevent water from entering the mechanism. Do not operate the crown under water.

Cleaning: for metal bracelets, rubber straps and water-resistant cases, use a toothbrush and soapy water for cleaning and dry with a soft cloth.

Chemical products: avoid direct contact with solvents, detergents, perfumes, cosmetics, insect repellents, etc., since they may damage the bracelet, case or gaskets.

Temperature: avoid exposure to extreme temperatures (greater than 60°C, or 140°F, less than 0°C, or 32°F) or extreme temperature changes.

Water-resistance: a watch's water-resistance cannot be permanently guaranteed. It may notably be affected by the ageing of gaskets or by an accidental shock to the crown. We recommend you have the water resistance of your watch checked once a year by an authorised OMEGA Service Centre.

Chronograph push-pieces: do not operate chronograph pushers under water in order to prevent water entering the mechanism. With the exception of the Seamaster Diver 300M and Planet Ocean 600M chronograph models which have functional pushers under water.

What are the service intervals?

Like any precision instrument, a watch needs regular servicing to ensure that it functions perfectly. We cannot indicate the frequency of such work, since it depends entirely on the model, the climate and the owner's individual care of the watch. As a general rule, a watch should be serviced every 5 to 8 years, depending on the conditions in which it is used.

Who should I contact for a maintenance service or battery replacement?

Please contact an approved OMEGA service centre or authorised OMEGA retailer. They are equipped with the tools and apparatus required to carry out the work and the necessary checks in a professional manner. Furthermore, these entities can guarantee that their work is carried out in accordance with OMEGA's strict quality standards.

A battery which has drained should be replaced immediately in order to reduce the risk of leakage and consequent damage to the movement. The type of battery is defined on the guarantee card enclosed with your watch.



ONLY APPLIES TO WATCHES WITH A QUARTZ MOVEMENT

⚠ WARNING	
<ul style="list-style-type: none"> • INGESTION HAZARD: This product contains a button cell or coin battery. • DEATH or serious injury can occur if ingested. • A swallowed button cell or coin battery can cause Internal Chemical Burns in as little as 2 hours. • KEEP new and used batteries OUT OF REACH OF CHILDREN • Seek immediate medical attention if a battery is suspected to be swallowed or inserted inside any part of the body. 	

- This product contains a battery that is not intended to be replaceable by the user.
- Immediately dispose of used batteries and keep away from children. Do NOT dispose of batteries in household trash.
- Even used batteries may cause severe injury or death.
- Call a local poison control center for treatment information.
- Do not mix old and new batteries, different brands or types of batteries, such as alkaline, carbon-zinc, or rechargeable batteries.
- Ensure the batteries are installed correctly according to polarity (+ and -).
- Remove and immediately discard batteries from equipment not used for an extended period of time.
- Non-rechargeable batteries are not to be recharged.
- Do not force discharge, recharge, disassemble, heat above (manufacturer's specified temperature rating) or incinerate. Doing so may result in injury due to venting, leakage or explosion resulting in chemical burns.

Type of battery used in OMEGA quartz movements 1376, 1424, 1532, 4061, 4561, 4564: silver oxide battery; references: 315, 321, 362, 364, 371, 373; nominal voltage: 1.55 V.

Collection and treatment of end of life Quartz watches*



This symbol indicates that this product should not be disposed with household waste. It has to be returned to a local authorised collection system. By following this procedure you will contribute to the protection of the environment and human health. The recycling of the materials will help to conserve natural resources.

* valid in EU member states and in any countries with corresponding legislation.

1 Introduction

Leather straps

OMEGA recommends that you follow the steps below in order to preserve the condition of your leather strap for as long as possible:

- avoid contact with water and dampness to prevent discolouration and deformation.
- avoid prolonged exposure to sunlight to prevent the colour from fading.
- do not forget that leather is permeable! Therefore avoid contact with greasy substances and cosmetic products.
- if you have a problem with your leather strap, please contact your nearest OMEGA retailer!

1 Introduction

Anti-reflective treatment



The anti-reflective treatment on both sides of the sapphire crystal improves the visibility of your watch's dial. Wear and tear may cause marks to appear. These are considered normal and are therefore not covered by the warranty.

1 Introduction

Screw-down crown



Some watches are fitted with a screw-down crown which must be unscrewed to alter the date and time. After use, push the crown into position 1 then press and screw the crown back down. Failure to screw the crown down will compromise water-resistance.

1 Introduction

OMEGA International Warranty

(Valid for U.S.A. only)

OMEGA SA* GUARANTEES YOUR WATCH FOR SIXTY (60) MONTHS UNDER THE TERMS AND CONDITIONS OF THIS WARRANTY, STARTING FROM THE DATE OF PURCHASE, FOR ALL OMEGA* WATCHES PURCHASED AS OF 1 JULY 2018.

The international OMEGA warranty covers material and manufacturing defects existing at the time of the purchase of the OMEGA watch ("defects"). The warranty only comes into force if the warranty certificate is dated, fully and correctly completed and stamped by an official OMEGA dealer ("valid warranty certificate").

During the warranty period and by presenting the valid warranty certificate, you will have the right to have any defect repaired free of charge. In the event that repairs are improper to restore the normal conditions of use of your OMEGA watch, OMEGA SA guarantees its replacement by an OMEGA watch of identical or similar characteristics. For all watches purchased as of 1 July 2018, the warranty for the replacement watch ends sixty (60) months after the date of purchase of the replaced watch.

This manufacturer's warranty does not cover:

- the life of the battery.
- normal wear and tear and ageing (for example scratched crystal; alteration of the colour and/or material of non metallic straps and chains, such as leather, textile, rubber).
- any damage on any part of the watch resulting from abnormal/abusive use, lack of care, negligence, accidents (knocks, dents, crushing, broken crystal, etc.), incorrect use of the watch and non-observance of the operating instructions provided by OMEGASA.
- the OMEGA watch handled by non-authorized persons (for example for battery replacement, service or repair) or which has been altered in its original condition beyond OMEGASA's control.

ALL APPLICABLE IMPLIED WARRANTIES, INCLUDING THE IMPLIED WARRANTY OF MERCHANTABILITY AND OF FITNESS FOR A PARTICULAR PURPOSE GIVEN TO YOU BY LAW ARE HEREBY LIMITED IN DURATION TO THE DURATION OF THIS WARRANTY. UNDER NO CIRCUMSTANCES WILL OMEGA SA BE LIABLE FOR ANY INDIRECT OR CONSEQUENTIAL DAMAGES OF ANY KIND.

Some states do not allow limitations on how long implied warranties last, or exclusions or limitations of incidental or consequential damages, so exclusions or limitations mentioned may not apply to you. This warranty gives you specific legal rights and you may also have other rights which may vary from state to state.

OMEGA SA's OBLIGATION IS STRICTLY LIMITED TO REPAIR OR REPLACEMENT AS EXPRESSLY STATED IN THIS LIMITED WARRANTY. YOUR AUTHORISED OMEGA RETAILER CARRIES SOLE RESPONSIBILITY FOR ANY OTHER GUARANTEES.

The OMEGA customer service ensures the perfect working order of your OMEGA watch. If your watch needs maintenance, rely on an authorised OMEGA retailer or an authorised OMEGA Service Centre in UK as set forth on the OMEGA website: they can guarantee service according to OMEGASA's standards.

* OMEGASA
Rue Jakob-Stämpfli 96
CH-2502 Bienne

OMEGA® and  are registered trademarks

OMEGA SA* guarantees your watch for sixty (60) months under the terms and conditions of this warranty, starting from the date of purchase, for all OMEGA* watches purchased as of 1 July 2018.

The international OMEGA warranty covers material and manufacturing defects existing at the time of the purchase of the OMEGA watch ("defects"). The warranty only comes into force if the warranty certificate is dated, fully and correctly completed and stamped by an official OMEGA dealer ("valid warranty certificate").

During the warranty period and by presenting the valid warranty certificate, you will have the right to have any defect repaired free of charge. In the event that repairs are improper to restore the normal conditions of use of your OMEGA watch, OMEGA SA guarantees its replacement by an OMEGA watch of identical or similar characteristics. For all watches purchased as of 1 July 2018, the warranty for the replacement watch ends sixty (60) months after the date of purchase of the replaced watch.

This manufacturer's warranty does not cover:

- the life of the battery.
- normal wear and tear and ageing (for example scratched crystal; alteration of the colour and/or material of non metallic straps and chains, such as leather, textile, rubber).
- any damage on any part of the watch resulting from abnormal/abusive use, lack of care, negligence, accidents (knocks, dents, crushing, broken crystal, etc.), incorrect use of the watch and non-observance of the operating instructions provided by OMEGASA.
- any consequential or indirect damage resulting from the use, failure to operate, defects or lack of precision of the OMEGA watch.
- the OMEGA watch handled by non-authorised persons (for example for battery replacement, service or repair) or which has been altered in its original condition beyond OMEGASA's control.

Any further claim against OMEGA SA, for example for damages additional to the above described warranty is expressly excluded, except mandatory statutory rights the purchaser may have against the manufacturer.

The above manufacturer's warranty:

- is independent of any warranty that may be provided by the seller, for which they carry sole responsibility;
- does not affect the purchaser's rights against the seller nor any other mandatory statutory rights the purchaser may have against the seller.

The OMEGA customer service ensures the perfect maintenance of your OMEGA watch. If your watch needs attention, rely on an authorised OMEGA retailer or an authorised OMEGA Service Centre as set forth in the enclosed list: they can guarantee service according to OMEGA SA's standards.

* OMEGA SA
Rue Jakob-Stämpfli 96
CH-2502 Bienne

OMEGA® and  are registered trademarks

NOTE: If you purchased your OMEGA® watch in Australia or New Zealand, the International OMEGA* Warranty contained in the booklet provided with this watch and on the OMEGA website (www.omegawatches.com) does NOT apply to you, and is replaced by this Australian / New Zealand Warranty (referred to below as the "Warranty").

IMPORTANT NOTICE REGARDING YOUR CONSUMER RIGHTS

The benefits given to you under this Warranty are additional to, and do not detract from, other rights and remedies that you may have in relation to your OMEGA watch and its purchase under Australian or New Zealand laws, including consumer protection laws.

In Australia, OMEGA watches come with guarantees that cannot be excluded under the Australian Consumer Law. You are entitled to a replacement or refund for a major failure and compensation for any other reasonably foreseeable loss or damage. You are also entitled to have your OMEGA watch repaired or replaced if it fails to be of acceptable quality and the failure does not amount to a major failure.

In New Zealand, OMEGA watches also come with guarantees that cannot be excluded under the New Zealand Consumer Guarantees Act.

This Warranty:

- Is not intended to change or exclude any statutory or consumer rights that cannot be lawfully changed or excluded;
- Is independent of any warranty that may be provided by the seller, for which they carry sole responsibility; and
- Does not affect your rights against the seller, including any mandatory statutory rights you may have against the seller under local consumer laws.

OUR WARRANTY TO YOU

This Warranty is provided by OMEGASA of Rue Jakob-Stämpfli 96, CH-2502 Bienne, Switzerland. Telephone +41 32 343 9211.

All OMEGA watches purchased as of 1 July 2018 are guaranteed for 5 years from the date of purchase under the terms and conditions of this warranty.

This Warranty covers material and manufacturing defects existing at the time of delivery of the purchased OMEGA watch ("defects"). Where such defects become apparent during the warranty period and provided you present a valid warranty certificate, OMEGASA will:

- Repair your watch free of charge; or
- In the event that repairs are unable to restore the normal conditions of use of your OMEGA watch, replace your watch with an OMEGA watch of identical or similar characteristics. Such replacement watch will have the benefit of this Warranty for the remainder of the Warranty Period applicable to the original (replaced) watch.

Please be aware that:

- Goods presented for repair may be replaced by refurbished goods of the same type rather than being repaired. Refurbished parts may be used to repair the goods;
- Any data you store in your watch may be lost in the course of a repair. It is your responsibility to back up any data that may be stored in your watch before presenting it for warranty service; and
- The Warranty is only valid if the warranty certificate enclosed with your OMEGA watch upon purchase is dated, fully and correctly completed, and stamped and signed by an authorised OMEGA retailer.

EXCLUSIONS AND LIMITATIONS

This Warranty does not cover:

- The lifetime of the battery;
- Normal wear and tear and aging (e.g. scratched crystal; alteration of the colour and/or material of non-metallic straps and chains, such as leather, textile, rubber; peeling of the plating);
- Any damage on any part of the watch resulting from abnormal/abusive use, lack of care, negligence, accidents (knocks, dents, crushing, broken crystal, etc.), incorrect use of the watch and non-observance of the use directions provided by OMEGASA;
- Indirect or consequential damages of any kind resulting from e.g. the use, the non-functioning, the defects or the inaccuracy of the OMEGA watch; or
- Defects caused by the OMEGA watch being handled by non-authorised persons (e.g. for battery replacement, services or repairs) or altered in its original condition beyond OMEGASA's control.

HOW TO MAKE A CLAIM UNDER THIS WARRANTY

To make a claim under this Warranty, we recommend that you wrap your OMEGA watch carefully so as to avoid any damage and send it by registered mail or drop it off in person to your nearest authorised OMEGA retailer or an official OMEGA Service Centre. To find current contact information for your nearest authorised OMEGA retailer or official OMEGA Service Centre, please telephone +61 3 8844 3314, email wecare.au@omegawatches.com.au or go to www.omegawatches.com.

You will be responsible for paying the expenses associated with making a claim under this Warranty, including postal or delivery expenses and any relevant taxes.

OTHER CONDITIONS

No authorised OMEGA retailer or official OMEGA Service Centre is authorised to make any modification, extension or addition to this Warranty. OMEGASA provides no warranty against defects beyond the rights and remedies given under this Warranty and which are available under the Australian Consumer Law and the New Zealand Consumer Guarantees Act 1993.

* OMEGASA
Rue Jakob-Stämpfli 96
CH-2502 Bienne

OMEGA® and  are registered trademarks of OMEGASA

CALIBRES 1376, 4061 (fig. IV)

The crown has 2 positions:

1. **Normal position (wearing position):** the crown pushed in against the case guarantees water resistance.
2. **Time setting:** pull the crown out to position 2, turn the crown forwards or backwards. Push the crown back to position 1.

CALIBRES 1532, 4561, 4564 (fig. I)

The crown has 3 positions:

1. **Normal position (wearing position):** the crown pushed in against the case guarantees water resistance.
2. **Correcting the date:** pull the crown out to position 2, turn the crown forwards or backwards. Push the crown back to position 1.
3. **Time setting:** pull the crown out to position 3. The seconds hand will stop. Turn the crown forwards or backwards. Synchronise the seconds by pushing the crown back to position 1 to coincide with a given time signal.

End of battery life indicator:

The end of battery life is indicated by the seconds hand making 4-second jumps. The watch will continue to function for several days, but the battery must be removed and replaced by an authorised OMEGA service agent as soon as possible.

CALIBRE 1424 (fig. I)

The crown has 3 positions:

1. **Normal position (wearing position):** the crown pushed in against the case guarantees water resistance.
2. **Time zone and correcting the date:** pull the crown out to position 2. Turn the crown forwards or backwards, the hour hand moves forwards or backwards in one-hour jumps. The date can be moved forwards or backwards by moving the hour hand past midnight accordingly. Push the crown back to position 1.
3. **Time setting:** pull the crown out to position 3. The seconds hand will stop. Turn the crown forwards or backwards. Synchronise the seconds by pushing the crown back to position 1 to coincide with a given time signal.

End of battery life indicator:

The end of battery life is indicated by the seconds hand making 4-second jumps. The watch will continue to function for several days, but the battery must be removed and replaced by an authorised OMEGA service agent as soon as possible.

CALIBRES 8500, 8501, 8507, 8508, 8511, 8900, 8901, 8910 (fig. I)

CALIBRES 8400, 8401, 8912, 8913, 8928, 8929 (fig. VI)

CALIBRES 8916, 8917 (fig. X)

CALIBRES 8926, 8927 (fig. XIV)

CALIBRES 8934, 8935 (fig. XV)

CALIBRE 8936 (fig. XVI)

The crown has 3 positions:

1. **Normal position (wearing position):** the crown pushed in against the case guarantees water resistance.

Occasional winding: if the watch has not been worn for 60 hours (72h: calibres 8910, 8928, 8929) or more, wind the watch by turning the crown whilst in position 1.

Calibres 8511, 8910, 8926, 8927, 8928 and 8929 - manual winding: turn the crown forwards until it stops (DO NOT OVERWIND).

Calibres 8934 and 8935 - manual winding: turn the crown forwards until the power reserve indicator hand is at the maximum position.

2. **Time zone and correcting the date:** pull the crown out to position 2. Turn the crown forwards or backwards; the hour hand moves forwards or backwards in one-hour jumps. The date jumps forwards or backwards each time the hour hand passes midnight. Push the crown back to position 1.

Note: the calibres 8400, 8401, 8912, 8913, 8926, 8927, 8928, 8929, 8934 and 8935 have no date indicator.

△ **NB:** when changing the time zone backwards, it is necessary to move the hour hand back past 7 pm to ensure the date changes.

- Time setting:** hours – minutes – seconds. Pull the crown out to position 3. The seconds hand will stop. Turn the crown forwards or backwards. Synchronise the seconds by pushing the crown back to position 1 to coincide with a given time signal.

Calibres 8934 and 8935 - Power reserve indicator:

(Indicator at 12 o'clock)

When the watch is fully wound, the power reserve indicator hand is at the maximum position (fig. 1).

Over time, the power reserve indicator hand gradually moves anti-clockwise.

When the power reserve indicator hand is in the last quarter (fig. 2), this means that the watch's power reserve is low. In this case, the watch should be manually wound to prevent it from stopping.

During manual winding (crown in position 1), the power reserve indicator hand moves clockwise.

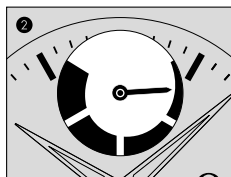
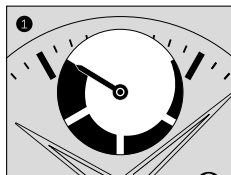

CALIBRES 8601, 8611, 8902, 8903 (fig. II)

CALIBRES 8922, 8923 (fig. XII)

The crown has 3 positions:

- Normal position (wearing position):** the crown pushed in against the case guarantees water resistance.

Occasional winding: if the watch has not been worn for 55 hours or more, wind the watch by turning the crown whilst in position 1.

- Annual calendar:** pull the crown out to position 2. Turn the crown forwards to change the date or backwards to change the month. Push the crown back to position 1.

Note: the day following 28 or 29 February (depending on whether it is a leap year), the date needs to be adjusted by one or two days (crown in position 2). Ideally, the date should be adjusted after setting the time. When correcting the date between midnight and 10 am, the effort required for the first jump is slightly greater than for the others.

△ **NB:** do not exit correction mode until the displays (date and month) are centred in the aperture.

Calibres 8922 and 8923: do not switch out of correction mode unless the date is centred in the window and the month hand centred in the month display.

- Time setting:** hours – minutes – seconds. Pull the crown out to position 3, the seconds hand will stop. Turn the crown forwards or backwards. Synchronise the seconds by pushing the crown back to position 1 to coincide with a given time signal.

△ **NB:** when changing the date backwards in time setting mode, it is necessary to wind the hands back to noon to ensure the date changes.

CALIBRES 8602, 8612 (fig. III)

The crown has 3 positions:

1. **Normal position (wearing position):** the crown pushed in against the case guarantees water resistance.

Occasional winding: if the watch has not been worn for 55 hours or more, wind the watch by turning the crown whilst in position 1.

2. **Correcting the day and the date:** pull the crown out to position 2. Turn the crown forwards to change the date or backwards to change the day. Push the crown back to position 1.

△ **NB:** do not quit setting mode if the displays (day and date) are not properly centred in their windows.

3. **Time setting:** hours – minutes – seconds. Pull the crown out to position 3. The seconds hand will stop. Turn the crown forwards or backwards. Synchronise the seconds by pushing the crown back to position 1 to coincide with a given time signal.

△ **NB:** when setting the day and date backwards in setting mode, it is necessary to go back to 2 pm to ensure that the day and date change at the right time.

**CALIBRES 2500, 2507, 8520, 8521, 8700, 8701, (fig.I)
8800, 8801****CALIBRES 2627, 8810, 8811 (fig. V)****CALIBRES 8802, 8803 (fig. X)****CALIBRES 8704, 8705 (fig. XI)**

The crown has 3 positions:

1. **Normal position (wearing position):** the crown pushed in against the case guarantees water resistance.

Occasional winding: if the watch has not been worn for 48 hours (55h: calibres 8800, 8801, 8802, 8803, 8810, 8811 and 50h: calibres 8520, 8521, 8700, 8701, 8704, 8705) or more, wind the watch by turning the crown whilst in position 1.

2. **Correcting the date:** pull the crown out to position 2, turn the crown backwards (forwards for calibres 8520, 8521, 8700, 8701, 8704 and 8705) and push it back to position 1.

△ **NB:** date-setting is not recommended between 8 pm and 2 am.

3. **Time setting:** hours – minutes – seconds. Pull the crown out to position 3. The seconds hand will stop. Turn the crown forwards or backwards. Synchronise the seconds by pushing the crown back to position 1 to coincide with a given time signal.

**Calibres 2627, 8810 and 8811 -
Power reserve indicator:**

(Indicator at 6 o'clock)

When the watch is fully wound, the power reserve indicator hand is at the maximum position (fig. 1).

If the watch is not being worn, or during periods of low activity, the power reserve indicator hand gradually moves anti-clockwise.

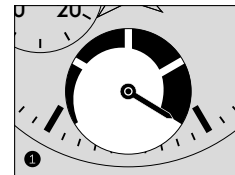

When the power reserve indicator hand is in the last quarter (fig. 2), this means that the watch's power reserve is low. In this case, the watch should be worn or manually wound to prevent it from stopping.

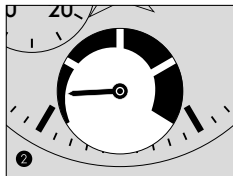

During manual winding (crown in position 1) or when being worn (self-winding), the power reserve indicator hand moves clockwise.

CALIBRES 2202, 2211, 8804, 8805 (fig. IX)

CALIBRES 2403, 8421, 8703, 8806, 8807 (fig. VIII)

The crown has 2 positions:

1. **Normal position (wearing position):** the crown pushed in against the case guarantees water resistance.

Occasional winding: if the watch has not been worn for 44 hours (50h; calibres 8421, 8703, 53h; calibre 2211 and 55h; calibres 8804, 8805, 8806, 8807) or more, wind the watch by turning the crown whilst in position 1.

Calibre 2211 - manual winding: turn the crown forwards until it stops (DO NOT OVERWIND).

2. **Time setting:** hours – minutes. Pull the crown out to position 2. Turn the crown forwards or backwards. Push the crown back to position 1.

Calibres 2202, 2403, 8421, 8703, 8804, 8805, 8806 and 8807: synchronise the seconds by pushing the crown back to position 1 to coincide with a given time signal.

CALIBRES 321, 1861, 1863, 1865, 1869, 3201, 3861, 3869 (fig. XX)

CALIBRE 3203 (fig. XXI)

Watch functions:

The crown has 2 positions:

1. **Normal position (wearing position):** the crown pushed in against the case guarantees water resistance.

Winding: turn the crown forwards until it stops (DO NOT OVERWIND).

Note: do not wind the watch more often than is necessary. For a watch that is worn all the time, a single winding each day will ensure that it functions correctly.

2. **Time setting:** hours – minutes – seconds. Pull the crown out to position 2. Turn the crown forwards or backwards. Synchronise the seconds by pushing the crown back to position 1 to coincide with a given time signal.

Note: calibres 321, 1861, 1863, 1865, and 1869 do not have a 'stop-second' mechanism. Therefore, it is not possible to synchronise the watch to the pip.

Chronograph functions:

- **Pusher A:** start – stop, start – stop, etc. Timekeeping with a resolution of 1/5 of a second up to 12 hours for the calibre 321.

Timekeeping with a resolution of 1/6 of a second up to 12 hours for the calibres 1861, 1863, 1865, 1869, 3861 and 3869.

Timekeeping with a resolution of 1/8 of a second up to 30 minutes for the calibre 3203.

Timekeeping with a resolution of 1/8 of a second up to 12 hours for the calibre 3201.

- **Pusher B:** reset (after a stop).

Note: resetting/zeroing of the sub dials must only be carried out after the chronograph has stopped. Never push the chronograph's two pushers (A and B) simultaneously (calibre 3201).

CALIBRE 9906 (fig. XXVII)

CALIBRES 9908, 9909 (fig. XXX)

Watch functions:

The crown has 3 positions:

1. **Normal position (wearing position):** the crown pushed in against the case guarantees water resistance.

Winding: turn the crown forwards until it stops (DO NOT OVERWIND).

Note: do not wind the watch more often than is necessary. For a watch that is worn all the time, a single winding each day will ensure that it functions correctly.

2. **Time zone and correcting the date:** pull the crown out to position 2. Turn the crown forwards or backwards; the hour hand moves forwards or backwards in one-hour intervals. The date jumps forwards or backwards each time the hour hand passes midnight. Push the crown back to position 1.

Note: the calibres 9908 and 9909 have no date indicator.

△ **NB:** when changing the time zone or date backwards, you must move the hour hand back past 7 pm to ensure the date changes.

3. **Setting the time:** hours – minutes – seconds. Pull the crown out to position 3, the seconds hand will stop. Turn the crown forwards or backwards. Synchronise the seconds by pushing the crown back to position 1 to coincide with a given time signal.

Chronograph functions:

- **Pusher A:** start – stop, start – stop, etc.
Timekeeping with a resolution of 1/8 of a second for up to 12 hours.
- **Pusher B:** reset (after a stop).

CALIBRE 3330 (fig. XXVI)**Watch functions:**

The crown has 2 positions:

1. **Normal position (wearing position):** the crown pushed in against the case guarantees water resistance.

Occasional winding: if the watch has not been worn for 52 hours or more, wind the watch with the crown in position 1.

2. **Time setting:** hours – minutes – seconds. Pull the crown out to position 2. The seconds hand will stop. Turn the crown forwards or backwards. Synchronise the seconds by pushing the crown back to position 1 to coincide with a given time signal.

Date correction: press the corrector (C) placed at 10 o'clock.

△ **NB:** *correcting is impossible between 8.30 pm and 11 pm.*

Chronograph functions:

- **Pusher A:** start – stop, start – stop, etc.
Timekeeping with a resolution of 1/8 of a second for up to 12 hours.
- **Pusher B:** reset (after a stop).

Note: *The zeroing function should only be performed after the chronograph has stopped.*

CALIBRE 3304 (fig. XXIII)**CALIBRE 3888 (fig. XXV)****CALIBRE 3113 (fig. XXXI)****Watch functions:**

The crown has 3 positions:

1. **Normal position (wearing position):** the crown pushed in against the case guarantees water resistance.

Occasional winding: if the watch has not been worn for 48 hours (52h; calibres 3113, 3888) or more, wind the watch by turning the crown whilst in position 1.

2. **Correcting the date:** pull the crown out to position 2, turn the crown forwards then push the crown back to position 1.

△ **NB:** *the date cannot be corrected between 8.30 pm and 1 am. (see note below for the calibre 3888).*

Calibre 3304 - date correction: press the corrector (C) placed at 10 o'clock.

Calibre 3888 - day correction: pull the crown out to position 2, turn the crown back, then push the crown back to position 1.

Note: *in the quick mode, the date is changed in two steps. Check that the date hand is centred after the change has been made. Date-setting is not recommended between 10 pm and 2 am. During this time lapse and under certain conditions, a safety element can prevent these corrective functions from working.*

3. **Time setting:** hours – minutes – seconds. Pull the crown out to position 3. The seconds hand will stop. Turn the crown forwards or backwards. Synchronise the seconds by pushing the crown back to position 1 to coincide with a given time signal.

Chronograph functions:

- **Pusher A:** start – stop, start – stop, etc.
Timekeeping with a resolution of 1/8 of a second for up to 12 hours or up to 7 days for calibre 3888.
- **Pusher B:** reset (after a stop).

CALIBRES 9300, 9301, 9900, 9901, 9920 (fig. XXVII)

Watch functions:

The crown has 3 positions:

1. **Normal position (wearing position):** the crown pushed in against the case guarantees water resistance.

Occasional winding: if the watch has not been worn for 60 hours or more, wind the watch by turning the crown whilst in position 1.

2. **Time zone and correcting the date:** pull the crown out to position 2. Turn the crown forwards or backwards, the hour hand moves forwards or backwards in one-hour jumps. The date can be moved forwards or backwards by moving the hour hand past midnight accordingly. Push the crown back to position 1.

△ **NB:** when changing the time zone backwards, it is necessary to move the hour hand back past 7 pm to ensure the date changes.

3. **Time setting:** hours – minutes – seconds. Pull the crown out to position 3. The seconds hand will stop. Turn the crown forwards or backwards. Synchronise the seconds by pushing the crown back to position 1 to coincide with a given time signal.

Chronograph functions:

- **Pusher A:** start – stop, start – stop, etc.
Timekeeping with a resolution of 1/8 of a second for up to 12 hours.
- **Pusher B:** reset (after a stop).

CALIBRES 9904, 9905 (fig. XXIX)**Watch functions:**

The crown has 3 positions:

1. **Normal position (wearing position):** the crown pushed in against the case guarantees water resistance.

Occasional winding: if the watch has not been worn for 60 hours or more, wind the watch by turning the crown whilst in position 1.

2. **Date and moon phase correction:** Pull the crown out to Position 2. Move the crown forward to correct the moon phase. Shift the disc forward to "full moon" position, then turn the crown past enough "notches" to get rid of the days since the last full moon (consult a lunar calendar). Turn the crown backwards to correct the date. Return the crown to position 1.

3. **Time setting:** hour – minute – seconds. As you pull the crown out to Position 3, the seconds hand will stop. Move the crown forward or backwards as needed. Synchronise seconds by pushing the crown back to position 1 at the stroke of the hour.

Chronograph functions:

- **Pusher A:** start – stop, start – stop, etc.
Timekeeping with a resolution of 1/8 of a second for up to 12 hours.
- **Pusher B:** reset to zero (after a stop).

CALIBRE 9914 (fig. XXIX)**Watch functions:**

The crown has 3 positions:

1. **Normal position (wearing position):** the crown pushed in against the case guarantees water resistance.

Winding: turn the crown forwards until it stops (DO NOT OVERWIND).

Note: do not wind the watch more often than is necessary. For a watch that is worn all the time, a single winding each day will ensure that it functions correctly.

2. **Date and moon phase correction:** pull the crown out to position 2. Turn the crown forwards to correct the moon phase. Shift the disc to the "full moon" position, then turn the crown to move the disc through as many "notches" as there are days since the last full moon (consult a lunar calendar). Turn the crown backwards to correct the date. Push the crown back to position 1.

3. **Setting the time:** hours – minutes – seconds. Pull the crown out to position 3, the seconds hand will stop. Turn the crown forwards or backwards. Synchronise the seconds by pushing the crown back to position 1 to coincide with a given time signal.

Chronograph functions:

- **Pusher A:** start – stop, start – stop, etc.
Timekeeping with a resolution of 1/8 of a second for up to 12 hours.
- **Pusher B:** reset (after a stop).

CALIBRE 3612 (fig. XXII)**Watch functions:**

The crown has 3 positions:

1. **Normal position (wearing position):** the crown pushed in against the case guarantees water resistance.

Occasional winding: if the watch has not been worn for 52 hours or more, wind the watch by turning the crown whilst in position 1.

2. **Correcting the date:** pull the crown out to position 2, turn the crown backwards, then push the crown back to position 1.

△ **NB:** the date cannot be corrected between 9 pm and 12.30 am.

3. **Time setting:** hours – minutes – seconds. Pull the crown out to position 3. The seconds hand will stop. Turn the crown forwards or backwards. Synchronise the seconds by pushing the crown back to position 1 to coincide with a given time signal.

Chronograph functions:

- **Pusher A:** start – stop, start – stop, etc.
Timekeeping with a resolution of 1/8 of a second for up to 12 hours.
- **Pusher B:** reset (after a stop).

Note: the chronograph must always be stopped before the zero resetting function is used. Never push the chronograph's two pushers (A and B) simultaneously.

Chronograph functions with split-seconds:

The split-seconds function allows split times to be recorded whilst the chronograph is running.

1. Start the chronograph by pressing pusher (A) (start).
2. To record a split time, press pusher (C). The split-seconds hand (D) stops, indicating the split time, whilst the chronograph continues running.

△ **NB:** the split time should be read immediately, since the chronograph totalisers for hours (G), minutes (E) and seconds (F) continue to measure the elapsed time.

3. Press pusher (C) for the split-seconds hand (D) to catch up with the chronograph seconds hand (F).
4. To record a new split time, start from step 2 above.
5. Press pusher (A) to stop the chronograph.
6. Press pusher (B) to reset.

△ **NB:** the split-seconds hand (D) must have caught up with the chronograph seconds hand (F) as explained in step 3 before the chronograph mechanism is reset/zeroed.

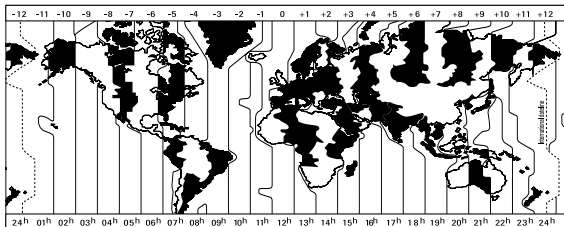

People travelling **East**, for example from London to Hong Kong, should pull the crown out to position 2 and move the hour hand forwards (in this case by 8 hours). The table above can be used to calculate any time difference.

People travelling **West**, for example from London to New York, should pull the crown out to position 2 and move the hour hand backwards (in this case by 5 hours). The table above can be used to calculate any time difference.

In both cases, the '24-hour' hand or disc allows travellers to read the time back home – London, in our example – at a glance, using the 24-hour scale on the dial. The second time zone – in this case Hong Kong or New York – is read off the dial in the usual way. Each time the hour hand crosses midnight, the date jumps forwards or backwards, depending on whether the hour hand is moved forwards or backwards.

CALIBRES 8605, 8615, 8906 (fig. VII)

CALIBRE 3603 (fig. XXIV)

CALIBRES 8938, 8939 (fig. XIII)

CALIBRES 9605, 9615 (fig. XXVIII)

Watch functions:

The crown has 3 positions:

- 1. Normal position (wearing position):** the crown pushed in against the case guarantees water resistance.

Occasional winding: if the watch has not been worn for 60 hours (52h: calibre 3603) or more, wind the watch by turning the crown whilst in position 1.

- 2. Setting the time zone and correcting the date:** pull the crown out to position 2. Turn the crown forwards or backwards, and only the hour hand will move forwards or backwards by 1-hour intervals. By passing the hour hand over midnight, the date can be changed forwards or backwards. Push the crown back to position 1.
- 3. Time setting:** 24 hours – hours – minutes – seconds. Pull the crown to position 3. The seconds hand will stop. Turn the crown forwards or backwards. Synchronise the seconds by pushing the crown back to position 1 to coincide with a given time signal.

Calibres 8605, 8615, 8906, 3603, 9605 and 9615 - second time zone "GMT"

Thanks to the '24-hour' hand with its triangular point, travellers can read the time back home at a glance on the 24-hour scale on the dial.

Synchronisation of the hour hand with the '24-hour' hand:

Pull the crown out to position 2 and turn it to synchronise the hour hand with the time indicated by the '24-hour' hand on the 24-hour scale. Make sure you set the hour hand in the correct half of the day!

After synchronising the hour hand with the '24-hour' hand, you must set the time on your watch.

Calibres 8938 and 8939 - 24H "Worldtimer" disc:

Thanks to the '24-hour' disc, travellers can read the time in different time zones symbolised by cities or geographic areas on the dial.



Setting the time and the date:

Pull the crown out to position 3. By turning the crown, move the minutes hand and the 24-hour universal time disc forwards until they indicate the UTC (Coordinated Universal Time) time. The display of the 24-hour universal time must be set in such a way that the time corresponding to the different time zones (represented by cities or geographic areas on the dial) is correct.

Push the crown back to position 1 to start the movement.

Pull the crown out to position 2. By turning the crown, move the hour hand forwards or backwards in one-hour increments to set the date, then position this hand on the time that corresponds to the time zone selected. As the date will change at midnight, make sure you set the hour hand in the correct half of the day!

For cities/geographic areas with summer time, add an additional hour to the hour indicated on the watch when summer time is in effect.

Calibres 3603, 9605 and 9615 - chronograph functions:

- **Pusher A:** start – stop, start – stop, etc.
Timekeeping with a resolution of 1/8 of a second for up to 12 hours.
- **Pusher B:** reset (after a stop).

Note: the chronograph function must always be stopped before the zero resetting function is used. Never push the chronograph's two pushers (A and B) simultaneously (calibre 3603).



OMEGA watches with a chronometer-certified movement

A chronometer is a high-precision watch whose movement has been individually tested, for 15 days in 5 positions and at 3 temperatures, by a neutral official body in accordance with the ISO 3159 (NIHS 95-11) Standard. Each chronometer is unique, and identified by a number engraved on its movement.

NIHS: Swiss Watchmaking Industry Standard

Master Chronometer OMEGA certified watches

In addition to the chronometer movement certification, Master Chronometer watches are individually tested at OMEGA for 10 days before they are delivered to the end customer. Test trials, based on a simulation of wear of the finished watch, aim to ensure the precision, resistance to magnetic fields (1.5 tesla / 15,000 gauss), power reserve and water-resistance of Master Chronometer watches. The process, measurement equipment, and results obtained for each watch are certified by METAS.

METAS: Federal Institute of Metrology (Switzerland)



Your OMEGA watch is designed to resist a magnetic field of 15,000 gauss. This is an intensity higher than any to which it will be exposed in everyday use (for example, the magnet in a handbag clasp may attain 2,000 gauss). Not only will your watch not stop in the presence of a magnetic field, it will not even suffer any loss of accuracy after being exposed to such a field.



Watches with thermocompensated quartz

This movement is equipped with an electronic module that balances out the influences of temperature on the precision of the quartz.

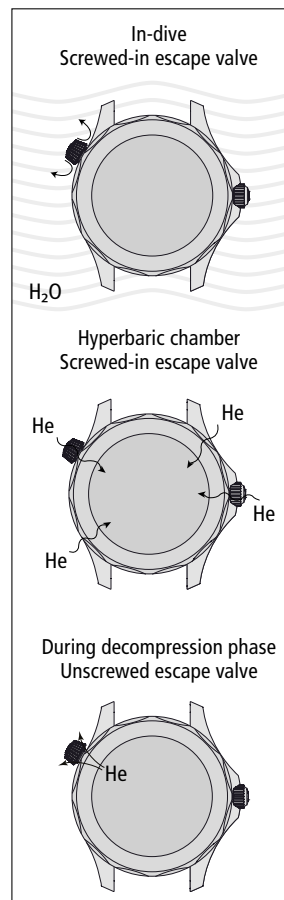

OMEGA Seamaster watches equipped with a helium escape valve, also known as a helium release valve, have been developed for professional or amateur divers who practise saturation diving. This type of technical diving is essentially used for under-water work carried out at great depths. Between two interventions, the diver is kept in a hyperbaric chamber at a pressure equivalent to the diving depth. He or she is exposed to a complex gaseous mix containing oxygen, hydrogen and helium, among other gases. This technique allows for very long diving times while reducing the risk of accidental decompression. Once the work is finished, the decompression phase begins, with the diver progressively returned to atmospheric pressure levels in the hyperbaric chamber.

During a long stay inside a hyperbaric chamber or under-water station, helium is diffused through all the water-resistant materials and penetrates the interior of the watch. During the decompression phase, the infiltrated helium generates excessive pressure in the watch, which can cause it to deteriorate. The function of the escape valve is to evacuate this high pressure during the decompression phase.



How to use the helium escape valve

Manual helium escape valve:

If your watch features a manual helium escape valve, the escape valve must always be screwed-in when diving so as to ensure perfect security against potential water entry.

The escape valve must only be unscrewed during the decompression phase (when the diver is returned to atmospheric pressure levels) inside a hyperbaric chamber.

NB: Even though the escape valve is unscrewed, the watch remains water resistant to a pressure of 5 bar (50 metres / 167 feet). Nevertheless, it is recommended that you always swim or dive with the escape valve screwed-in.

Variation with position indicator: the escape valve is equipped with a red indicator (A) that is visible in the unscrewed position.

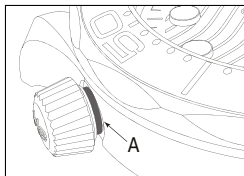

Variation with corrector: the escape valve is equipped with an integrated date corrector. The corrector (B) positioned in the centre of the escape valve is functional when the escape valve is fully screwed-in.

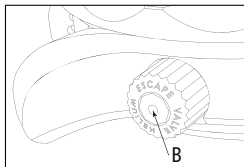

Automatic helium escape valve: if your watch possesses an automatic helium escape valve (C), no manipulation is necessary.

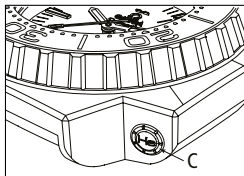

The desired information (tachometer; pulsimeter) is read off between the central seconds hand of the chronograph and the corresponding scale, over a maximum duration of 60 seconds. For the telemeter, it is possible to make use of the minutes counter by adding 20 km to the distance indicated by the central seconds hand for each minute elapsed.

Using the tachymetric scale

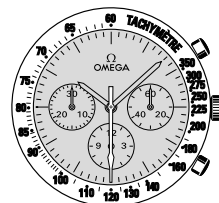

Example: calculating the speed of a car.

Record the time the car takes to cover a distance of 1 kilometre. Read off the tachymetric scale the speed indicated by the central seconds hand. In this case, the car is travelling at 120 km/h.

Using the pulsimetric scale

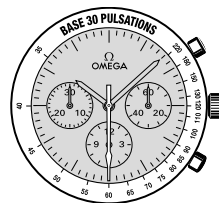

Example: calculating the number of heart-beats per minute.

Start the chronograph, count the heart-beats and stop it at the beat corresponding to the scale graduations of your chronograph (here to the 30th beat). Read the number of beats per minute off the pulsimetric scale: here, 60 beats/minute.



Using the telemetric scale

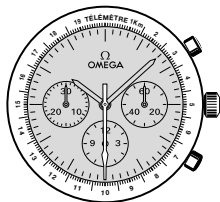

Example: calculate the distance between your position and an event producing light and sound simultaneously (e.g. a storm).

The chronograph is set off by the detection of light, for example a lightning strike. Then it stops on detection of the sound, the clap of thunder. Here, the storm is 9.9 km away.

Reading the chronograph minute counter (Seamaster Diver 300M, ETNZ 2015)



Example: counting down the time before the start of a regatta.

3H counter:

The inside timer displays the minutes of the chronograph using the white part of the Regatta needle.

The outside timer displays the 5-minute countdown before the start of the regatta.

The chronograph is started at the first horn blast, 5 minutes before the start of the regatta, to allow the yachtsman to position his boat closer to the starting line.

Reading the chronograph minute counter (Seamaster Diver 300M, 36th America's Cup)



Example: counting down the time before the start of a regatta.

3H counter:

The counter has a minute hand and an hour window. The white part of the indicator represents the 10-minute countdown to the start of the regatta. The pre-regatta phase is divided into 2 parts, the first 5 minutes are allocated to preparing the boat and crew and the other 5 minutes to the positioning of the boat.

The chronograph is started at the first signal, 10 minutes before the start of the regatta.

Only OMEGA straps, specially designed for these folding clasps, should be used. For your own peace of mind and convenience, we recommend that you have your new clasp fitted by an authorised OMEGA service centre. You can always adjust the length of the bracelet yourself.

Opening (fig. 1): to press the 2 push-buttons on the sides of the buckle and pull upwards.

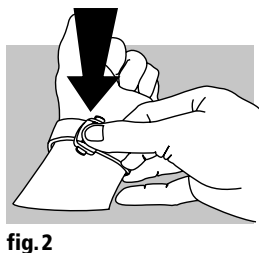
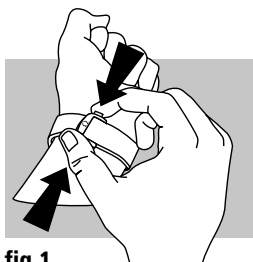

Closing (fig. 2): put your OMEGA watch on your wrist and close the buckle until you hear a click.

Adjusting the length (fig. 3): free the longer section from the two slideways (A) and from the catch (B). Adjust the bracelet in the required direction and reinsert in the catch and the two slideways. Try the watch for size and readjust if necessary.

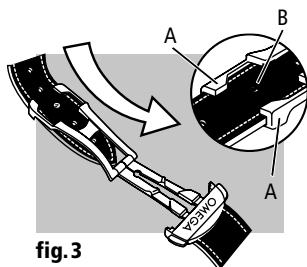

Triple-blade folding clasp:

Opening (fig. 1): to open your clasp, press the two pushers on either side of the OMEGA buckle and pull upwards.

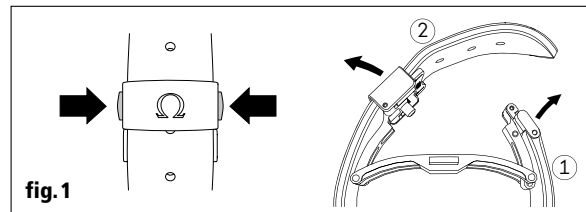

Closing: put the OMEGA watch on your wrist and press down the tab located at the 12 o'clock position ①. Insert the end of the strap located at the 6 o'clock position ② into the leather loop, then close the tab located at the 6 o'clock position by pushing it down until you hear a click.

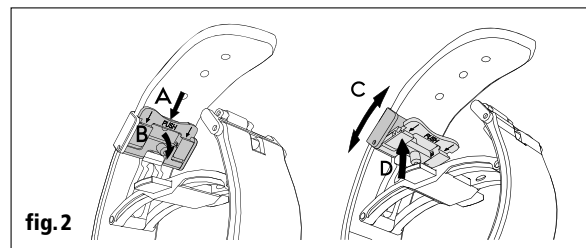

Adjusting the length (fig. 2): press down on the pusher labeled "PUSH" in the direction of arrow (A) and loosen the strap end (B). Slide the strap within the cover to place it in the desired setting position (C). Press down on the mobile system to lock it, ensuring that the hole is placed over the stud so that you do not damage the strap end (D). Try the watch for size and readjust if necessary.

Foldover clasp for metal mesh bracelet:

Opening (fig. 1): press the two pushers on the sides of the clasp and pull upwards.

Closing (fig. 2): put your OMEGA watch on your wrist and fasten the clasp until you hear a click.

Adjusting the length of the bracelet (fig. 3): lift the locking tab to release the strap end. Slide the strap to your desired length and lock it in position with the locking tab until it clicks.

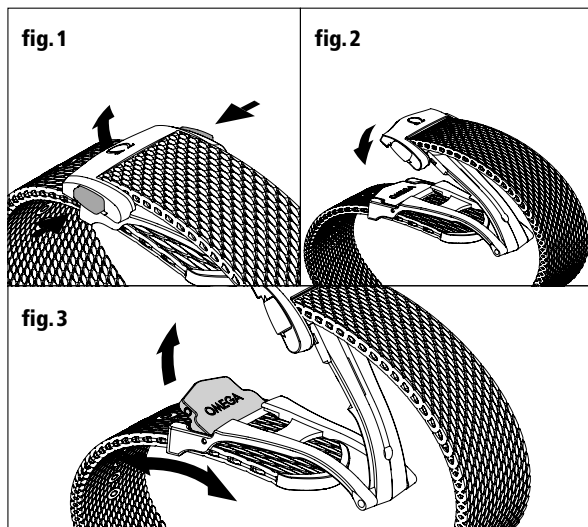

Buckle for metal mesh bracelet:

Opening (fig. 1): press the two pushers on the sides of the clasp and pull upwards.

Closing (fig. 2): put your OMEGA watch on your wrist, insert the strap inside the slideways and fasten the clasp until you hear a click.

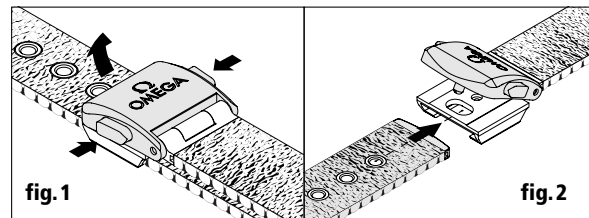

Adjusting the length of the bracelet (fig. 3): open the clasp to free the longer section from the catch. Adjust the bracelet in the required direction and reinsert in the catch. Try the watch for size and readjust if necessary.

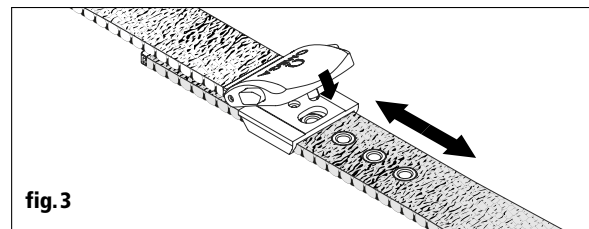

Rack-and-pusher clasps:

Using the fine length adjuster:

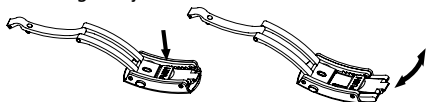

Extendable foldover rack-and-pusher clasps:

Using the fine length adjuster:

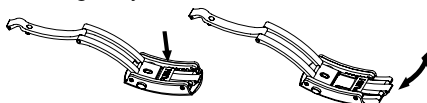

Using the diving extension:



Ploprof clasps:

Using the fine length adjuster:



Using the diving extension:



Note: to fold the diving extension away, repeat the steps in reverse order.

Butterfly clasp with a built-in extension system:

Built-in extension system adjustment: to open your clasp, press the two pushers (A) on either side of the cover and pull upwards (B).

Unfold the strap end (C) while pressing the pusher (D) located on the base and slide the tab (E) to the desired position.

Release the pusher once in the correct position and close the strap end located at 6 o'clock (F) then 12h (G).

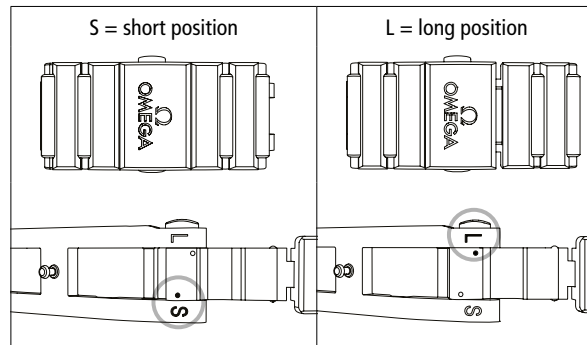
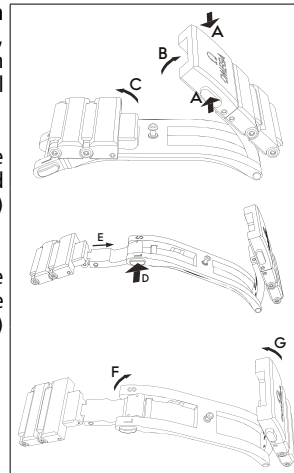

3 Specific sections/general information Ploprof bezel and crown

How to use the rotating bezel: press down on the pusher (A) to rotate the bezel.

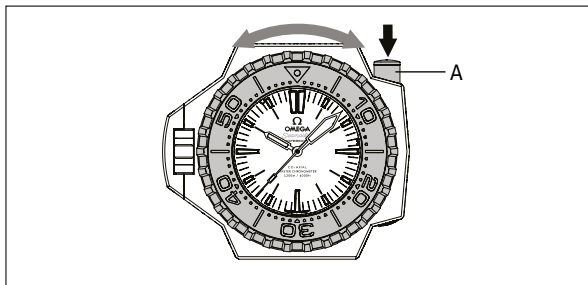

How to use the crown: to use the crown (B), unscrew it beforehand, the crown-protection (C) will then slide without rotating. After use, push the crown to position 1, then press and screw down the crown (to ensure the case remains waterproof).

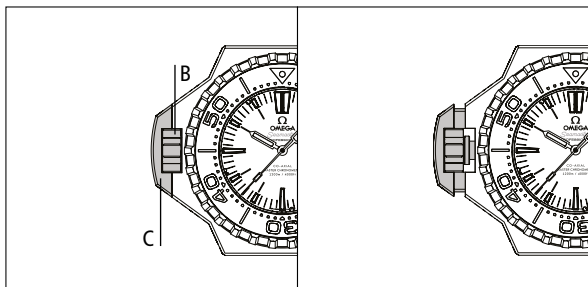

Note: the crown is at 9 o'clock, but the functions are the same.

3 Specific sections/general information Bullhead crown

Screwing down the Bullhead crown: to screw down the Bullhead crown, position the crown so that the black mark is against the top (fig. 1), then press and turn the crown clockwise by 90° (fig. 2).

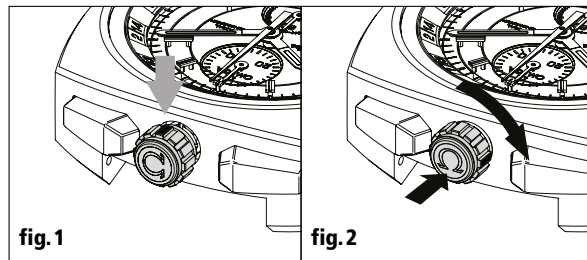

3 Specific sections/general information Retractable crown

How to use the retractable crown: press on the crown, then release it to move it to position 1. By pulling on the crown, you can move it to positions 2 and 3. To return to a lower position, you must retract the crown to position 0 (normal wearing position) before returning it to position 1 or 2.

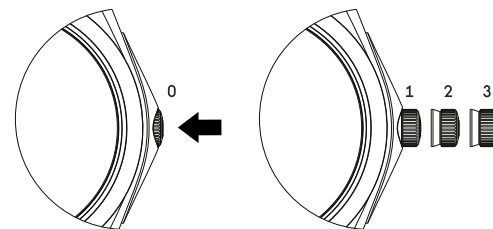

3 Specific sections/general information CHRONO LOCK

CHRONO LOCK is a system which blocks the chronograph pushers to prevent involuntary action and secure your timekeeping.

How to use the CHRONO LOCK: when the locking ring is in LOCK position (A), the pushers are locked.

To unlock, push the locking ring to CHRONO position (B), the pushers can then be activated.

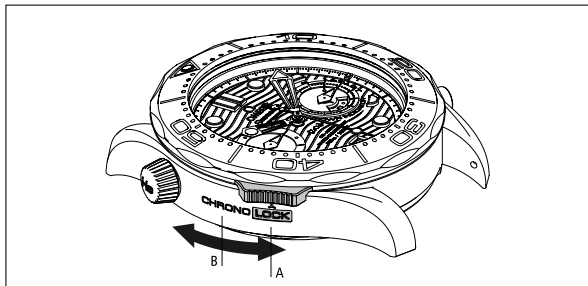

3 Specific sections/general information Strap with quick interchangeable system

How to use the Strap with quick interchangeable system:

To take off a rubber strap (fig. 1): slide the button downwards then release the bracelet from between the lugs to remove it from the watch case.

To put on a rubber strap (fig. 1-3): slide the button downwards to retract the pivots. Insert the strap between the lugs on the watch case.

3 Specific sections/general information Strap with quick interchangeable system









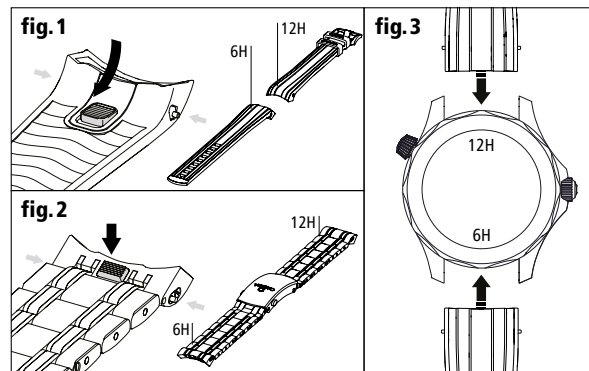















Release the button then delicately manoeuvre the strap between the lugs until the pivots are in place.



























To take off a steel strap (fig. 2): press on the button then release the bracelet from between the lugs to remove it from the watch case.

To put on a steel strap (fig. 2-3): press on the button to retract the pivots. Insert the strap between the lugs on the watch case. Release the button then delicately manoeuvre the strap between the lugs until the pivots are in place.

- △ **Visually check that your strap or bracelet is correctly inserted between the lugs and ensure that both parts of the strap or bracelet are securely fastened to the watch case by pulling gently on the strap or bracelet.**



	Calibre number		Moon phase
	Certification Master Chronometer		End of battery life indicator
	Co-Axial escapement		Tachymeter
	Si14 silicon balance-spring		Pulsimeter
	Spirate™ system		Telemeter
	Resistant magnetic field = 15,000 gauss (1.5 tesla)		Sapphire crystal
	Thermocompensated quartz movement		Anti-reflective treatment
	Quartz		Double-sided anti-reflective treatment
	Self-winding		Sapphire crystal case back
	Manual-winding		Ceramic case
	Chronometer		Screw-down crown
	Chronograph		Helium escape valve
	Time zone function		Gold 750‰
	Annual calendar		Sedna™ Gold Gold 750‰
	Date		Canopus Gold™ Gold 750‰
	Perpetual calendar		Moonshine™ Gold Gold 750‰
	Split-seconds		Bronze Gold Gold 375‰
	Power reserve indicator		950‰ platinum
	Second time zone		950‰ palladium
	Worldtimer (WT)		Liquidmetal™
	Day-date		OMEGA CERAGOLD™

	Gamma Titanium		Water-resistant to a relative pressure of 12 bar (120 metres/390 feet)
	Titanium		Water-resistant to a relative pressure of 13.5 bar (135 metres/440 feet)
	O-MEGASTEEL		Water-resistant to a relative pressure of 15 bar (150 metres/500 feet)
	Ceramic bezel		Water-resistant to a relative pressure of 20 bar (200 metres/660 feet)
	Diamond(s) set		Water-resistant to a relative pressure of 30 bar (300 metres/1000 feet)
	Limited edition		Water-resistant to a relative pressure of 60 bar (600 metres/2000 feet)
	Numbered edition		Water-resistant to a relative pressure of 100 bar (1000 metres/3300 feet)
	5-year international guarantee		Water-resistant to a relative pressure of 120 bar (1200 metres/4000 feet)
	WEEE regulation		Water-resistant to a relative pressure of 20000 feet
	Button-type zinc-silver oxide primary battery cell		Diver's watch for saturation diving in accordance with the ISO 6425:2018 standard
	Button-type lithium-manganese dioxide primary battery cell		
	Not water-resistant		
	Water-resistant to a relative pressure of 3 bar (30 metres/100 feet)		
	Water-resistant to a relative pressure of 5 bar (50 metres/167 feet)		
	Water-resistant to a relative pressure of 6 bar (60 metres/200 feet)		
	Water-resistant to a relative pressure of 10 bar (100 metres/330 feet)		

OMEGA boutiques

Ω
OMEGA

Please visit www.omegawatches.com/stores for a list of our OMEGA agents
请前往 www.omegawatches.cn/stores/zh 欧米茄销售点列表



English



中文

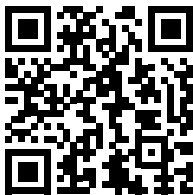

OMEGA authorized service centres

Ω
OMEGA
SERVICE CENTRE

Please visit www.omegawatches.com/service-centres for a list of OMEGA authorized service centres

请前往 www.omegawatches.cn/cn/customer-service 欧米茄特约维修中心列表



English



中文



Importers of OMEGA products into the European Union, the United Kingdom and Norway

Importateurs des produits OMEGA pour l'Union Européenne, le Royaume-Uni et la Norvège

Importeure von OMEGA Produkten für die Europäische Union, das Vereinigte Königreich und Norwegen

Country	Importer according to the customs documentation	Address for information in case of need
Austria Österreich	The Swatch Group (Österreich) GmbH Ares Tower Donau-City-Strasse 11 1220 Wien Austria	The Swatch Group (Österreich) GmbH Ares Tower Donau-City-Strasse 11 1220 Wien Austria
Belgium België Belgien Belgique	The Swatch Group (Belgium) SA/NV Chaussée de Mons 1424 1070 Bruxelles Belgium	The Swatch Group (Belgium) SA/NV Chaussée de Mons 1424 1070 Bruxelles Belgium
Bulgaria Република България	GIULIAN LTD. 11 Paris str., Office #2, floor #1 1000 Sofia Bulgaria	GIULIAN LTD. 11 Paris str., Office #2, floor #1 1000 Sofia Bulgaria
Cyprus Κύπρος Kibris	The Swatch Group Greece S.M.S.A. Sygrou & 3 Mantzagriotaki Str. Kallithea 17672 Athens Greece	The Swatch Group Greece S.M.S.A. Sygrou & 3 Mantzagriotaki Str. Kallithea 17672 Athens Greece
Croatia Hrvatska	SLOWATCH D.O.O. Produtiska Cesta 152 1000 Ljubljana Slovenia	SLOWATCH D.O.O. Produtiska Cesta 152 1000 Ljubljana Slovenia
Czech Republic Česká Republika	KVEDU Praha S.R.O. Na Prikope 17 110 00 Praha 1 Czech Republic	KVEDU Praha S.R.O. Na Prikope 17 110 00 Praha 1 Czech Republic

Denmark Danmark	The Swatch Group (Nordic) Helleruphus Strandvejen 102 B, 4th. floor 2900 Hellerup Denmark	The Swatch Group (Nordic) Helleruphus Strandvejen 102 B, 4th. floor 2900 Hellerup Denmark
Finland Suomi	The Swatch Group (Nordic) Äyritie 12 B 01510 Vantaa Finland	The Swatch Group (Nordic) Äyritie 12 B 01510 Vantaa Finland
France	The Swatch Group (France) S.A.S. 112-114, avenue Kléber 75116 Paris France	The Swatch Group (France) S.A.S. 112-114, avenue Kléber 75116 Paris France
Germany Deutschland	The Swatch Group (Deutschland) GmbH Frankfurter Straße 20 65760 Eschborn Germany	The Swatch Group (Deutschland) GmbH Frankfurter Straße 20 65760 Eschborn Germany
Greece Ελλάδα	The Swatch Group Greece S.M.S.A. Sygrou & 3 Mantzagriotaki Str. Kallithea 17672 Athens Greece	The Swatch Group Greece S.M.S.A. Sygrou & 3 Mantzagriotaki Str. Kallithea 17672 Athens Greece
Hungary Magyarország	KZM Király utca 52 l.em 8 1065 Budapest Hungary	KZM Király utca 52 l.em 8 1065 Budapest Hungary
Ireland Éire	The Swatch Group (UK) Limited Building 1000, 2nd Floor East Wing The Royals Business Park Dockside Road London E16 2QU United Kingdom	The Swatch Group (UK) Limited Building 1000, 2nd Floor East Wing The Royals Business Park Dockside Road London E16 2QU United Kingdom

Italy Italia	The Swatch Group (Italia) S.p.A. Via Washington 70 20146 Milano Italy	The Swatch Group (Italia) S.p.A. Via Washington 70 20146 Milano Italy
Latvia Latvija	DIMAX SIA 1 - 1 Valnu 1050 Riga Latvia	DIMAX SIA 1 - 1 Valnu 1050 Riga Latvia
Lithuania Lietuva	BEGALYBES VALDYMAS Antano Tumeno G. 4-10 01009 Vilnius Lithuania	BEGALYBES VALDYMAS Antano Tumeno G. 4-10 01009 Vilnius Lithuania
Luxembourg Letzebuerg	The Swatch Group (Belgium) SA/NV Chaussée de Mons 1424 1070 Bruxelles Belgium	The Swatch Group (Belgium) SA/NV Chaussée de Mons 1424 1070 Bruxelles Belgium
Malta	RJM Diffusion S.A. Avenue de la Gare 1 1003 Lausanne Switzerland	RJM Diffusion S.A. Avenue de la Gare 1 1003 Lausanne Switzerland
Netherlands Nederland	The Swatch Group (Netherlands) B.V. Kennedyplein 8 5611 ZS Eindhoven Netherlands	The Swatch Group (Netherlands) B.V. Kennedyplein 8 5611 ZS Eindhoven Netherlands
Norway Noreg Norge	The Swatch Group (Nordic) nuf Lørenveien 73D NO-0585 Oslo Norway	The Swatch Group (Nordic) nuf Lørenveien 73D NO-0585 Oslo Norway
Poland Polska	The Swatch Group (Polska) Sp. z o.o. ul. Marynarska 15 PL-02-674 Warsaw Poland	The Swatch Group (Polska) Sp. z o.o. ul. Marynarska 15 PL-02-674 Warsaw Poland
Portugal	Tempus Internacional S.A. Av. Infante D. Henrique Lote 1679, R/C Dto. CLJ. 1950 - 420 Lisboa Portugal	Tempus Internacional S.A. Av. Infante D. Henrique Lote 1679, R/C Dto. CLJ. 1950 - 420 Lisboa Portugal

